

LABORATORY REFERENCE SERIES

5M21

REALTIME PROCESSED DC POWER AMPLIFIER

A major breakthrough amplifier technology a new series of amplifiers incorporating total DC design ensuring the most faithful sound reproduction with lowest phase and transient distortion.

CONTENTS

- SWITCHES & TERMINALS 2
- CONNECTION PROCEDURE 6
- ABOUT POWER OUTPUT 8
- OPERATION PROCEDURE 9
- PROTECTIVE CIRCUITS 10
- BLOCK DIAGRAM 12
- STANDARD CURVES 13
- SPECIFICATIONS 16

WARNING: TO PREVENT FIRE OR SHOCK HAZARD
DO NOT EXPOSE THIS APPLIANCE TO
RAIN OR MOISTURE.

Thank you for your Selection of the 5M21/5M20

The 5M21/5M20 is a stereo power amplifier which constitutes the core of LUX's prestigious Hi-Fi components named "Laboratory Reference Series". The output is 100W per channel into 8 ohms load according to the FTC rules, and this is comprised in the category of high-powered amplifiers. Functionwise this is provided with 2 large VU meters to monitor an output power on both right and left channels, meter sensitivity, and DC offset sensor to check DC components at the input.

As explained by the words "REALTIME PROCESSED", with the 5M21/5M20 we delved not only into spatial wave form but also into time problem (phase) so as to ensure the most faithful amplification of the music signals—passing and un-repeatable wave-form signals. Especially to remove the phase distortion at the bass range a DC configuration was adopted, and also as regards the harmful notch distortion at the treble range, exhaustive study rendered on the components as well as the circuitry made it possible to reduce it lower than even that of class A amp without sacrifice of output power.

The advantage of DC amp has been fully appreciated, but such configuration has never been taken up by the major manufacturers because of its inherent drawback of DC drift triggered by fluctuation of temperature and other ambient conditions. However this barrier is successfully removed, and a DC amp of unconditional stability is realized thanks to the newly developed FET's differential circuit and its auxiliary circuit of DML-IC.

In addition, to ensure stable power supply to all the circuits involved, we combined 2 independent large toroidal power transformers for right and left channels with electrolytic capacitors of huge capacitance and low impedance. Such components as resistors, semi-variable resistors and capacitors are carefully selected.

We recommend you to choose with care other Hi-Fi components for the optimum operation in combination with this unit, and go through the contents of this owner's manual to make the most of the potentiality of this power amplifier.



SWITCHES & TERMINALS

1. V.U. METER

These two gigantic VU meters allow easy reading of the output level of the respective channels. The meter shows an average output level of the channel. The Meter Sensitivity Selector (2) is provided to enable reading of lower output level. With this switch (2) unpressed (OFF position), the 0dB point of the meter scale corresponds to the output power of 100 watts (8 ohm loads). With this switch (2) depressed (ON position), at the -10dB point, the output power of 10 watts (8 ohm loads). For further details, see the "ON OUTPUT POWER" section prescribed in this manual.
(This device is only for the 5M21.)

2. METER SENSITIVITY SELECTOR

This power amplifier is designed to give the 100 watts per channel (8 ohm) output power. However in actual use, driving of the amplifier in the vicinity of its maximum rating is rather seldom. Setting of meter sensitivity to the effect that

0dB indicates the maximum level may be inconvenient since the VU meter needle gives little or no swing at lower output level amplifier driving. For this reason, the Meter Sensitivity Selector is provided to boost the meter sensitivity by 10dB independent of the gain of the power amplifier permitting reading of the meter at lower output level. When this Selector is at the "off" position (not pressed in), the 0dB point of the VU METER (1) scale is equivalent to 100W/ch (8 ohm loads) and when this selector is ON at -10dB position (pressed in), the 0dB point, 10W/ch (8 ohm loads).
(This device is only for the 5M21.)

3. HEADPHONE JACK

Connection of a stereophonic headphone to this jack allows private listening. Insertion of the headphone plug into this jack automatically cuts off the speaker outputs.

4. DC OFFSET SENSOR/PILOT LAMP

As this power amplifier adopts the DC amplification circuitry,

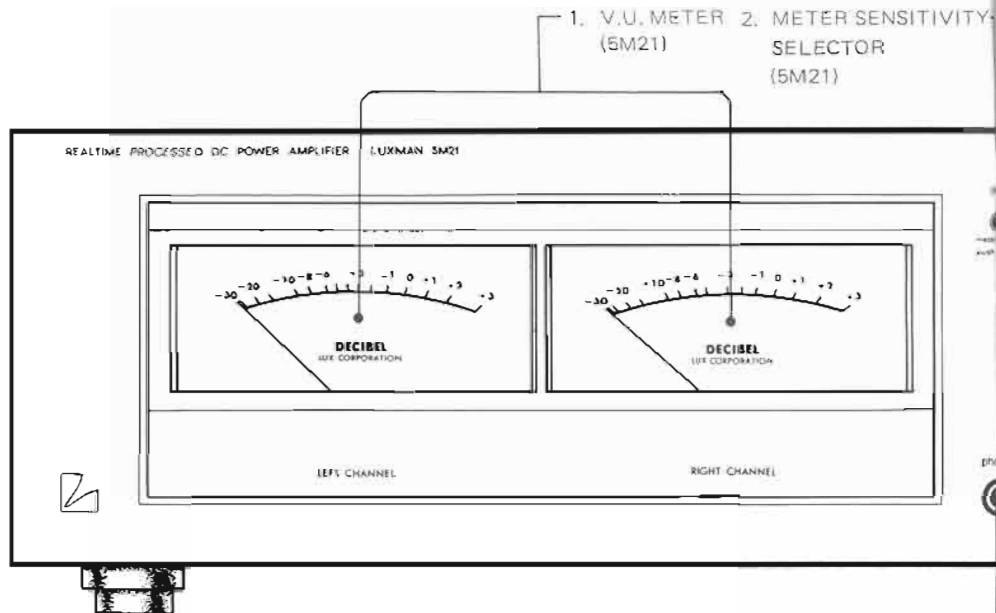

perfect measures against possible internal DC drifts have been integrated. However, leakage of DC ingredient from other audio component which is connected to this amplifier may be unavoidable. Such leakage will cause malfunctioning of the amplifier, then speakers, being fed with amplified DC ingredients, may be affected or in worst cases, broken down. The DC OFFSET SENSOR is added to the circuitry to monitor existence of any harmful DC ingredients at the output terminals. The SENSOR lamp serves bilaterally, as the power pilot lamp and the SENSOR light. The lamp continues to light up in white while no DC ingredient is fed to the input terminals of the amplifier. When $\pm 450\text{mV}$ or more voltage appears at the output terminals, color of the SENSOR light changes to red to give warning that DC ingredients are fed from exterior audio components. When such warning is made, lift the INPUT CAPACITOR IN/OUT SELECTOR (7) to select the "INPUT CAPACITOR" position.

And the harmful DC ingredients are blocked at the input, when color of the light returns to white within two or three seconds.

5. POWER SWITCH

This switch is for push-ON, push-OFF operation. To press in the switch, AC power is supplied and the pilot lamp (4) begins to blink which lasts for 5 ~ 20 seconds. As soon as the amplifier is warmed up for normal operating condition, white lamp indication stays. Simultaneously the VU meter lamps illuminate. To switch off the amplifier, press in the switch once again.

6. INPUT TERMINALS

Outputs of the mating control (pre) amplifier are connected to these terminals. Next to these terminals, independent attenuators (8) for the both channels are provided to permit flexible regulation of input sensitivity. The maximum input sensitivity of the terminals is 890mV, and the input impedance is 50K ohms. This means the maximum gain is obtainable by input signal level of 890mV when the INPUT ATTENUATOR (8) is set at the MAX. position (completely turned clockwise). Input sensitivity can be continuously decreased by turning of the ATTENUATOR to the counter-clockwise direction. At the extreme counter-clockwise end position (∞), input sensitivity is cut to zero and no audio signal is available from the output terminals.

Since the B-type variable resistor is used for the attenuators, at the central (neutral) point of the attenuator knob, sensitivity attenuation is 6dB from the maximum level and input sensitivity of this amplifier becomes 1.78V.

7. INPUT CAPACITOR IN/OUT SELECTOR

Since DC amplification is adopted, when any DC ingredients are fed to the input terminals of this amplifier from an external source, amplified DC ingredients will come out from the output terminals resulting in abnormal function of speakers, actuation of protective circuits, etc. To avoid such impediment, the DC OFFSET SENSOR is provided to give visible warning. The pilot/warning lamp (4) that normally lights in white turns to red when DC ingredients are sensed. As soon as the warning is given, set this SELECTOR, which is provided subsequent to the input

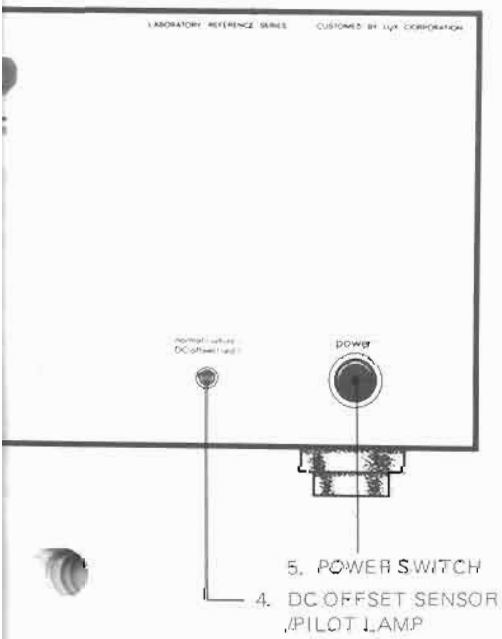

terminals, at the "INPUT CAPACITOR" position. By this selection, complete shut-off of DC ingredients from the external source is possible. The color of light will return to white from red within 2 ~ 3 seconds after selection.

The INPUT CAPACITOR IN/OUT SELECTOR is also useful for protection of the amplifier itself when for use with loading components of which impedance will become nearly zero in the extremely low frequency range; for example, electrostatic (condenser) speakers, speakers using dividing networks that use transformers for low frequency cut-off, etc.

8. ATTENUATOR

Input sensitivity can be regulated to optimum level by this control. Two independent attenuators are provided for the right and left channels and any unbalance of levels between the both channels can be adjusted. Viewed from the rear side of the amplifier, the left knob is for the right channel, and the right knob, the left channel. Continuous input level attenuation from 0dB down to ∞ is possible.

With the knob position completely turned clockwise, which is the MAX position, attenuation amount is 0dB (no attenuation). With the knob position completely turned counter-clockwise, which is the MIN position, attenuation amount is infinite (∞) and no sound playback is possible. The attenuator is the B type volume control and the attenuation is -8dB (1/2) at the neutral (central) point of the knob turning.

9. EARTH TERMINAL

Earth terminals of exterior component such as a preamplifier, a peak indicator and so forth must be connected to this terminal. To make A/B listening test of amplifiers, it will be effective to eliminate shock noise at changeover if this terminal is commonly used for grounding of the tested amplifiers.

10. PEAK INDICATOR CONNECTOR

The model 5E24 PEAK INDICATOR to give precise peak output level reading of the am-

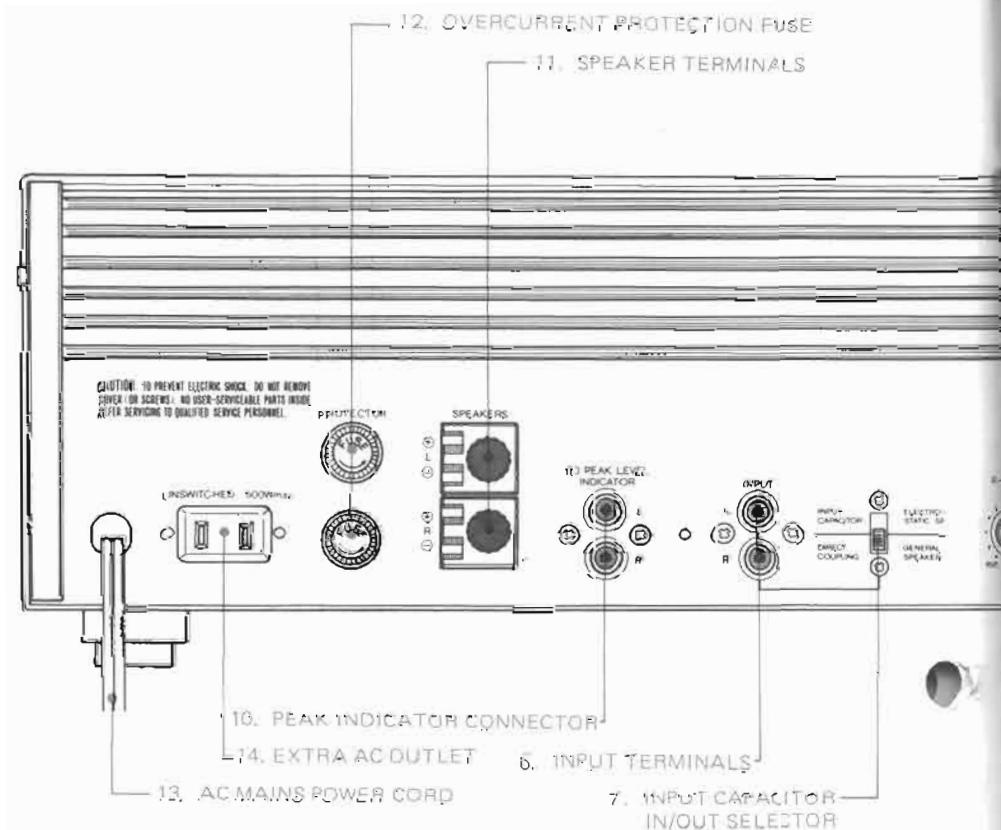





plifier by pure electronic circuitry is available in the LRS family. This connector is used for connection to the 5E24 PEAK INDICATOR when it is available.

11. SPEAKER TERMINALS

Connect the speaker system to these terminals. Speaker cables must have sufficient capacity for carrying audio output loads.

Correct connection is very important. Checks must be made whether the right channel output terminals are connected to the right speaker, and the left channel to the left speaker. Also correct phase matching is a must. Caution is necessary that the core lead is not short circuited to any other terminals or cables. To connect the speaker cable, strip off the shield at the end of the cable for approximately 10mm (3") and twist the core leads. Turn the knobs on the speaker terminals to the complete counter-clockwise end (), and insert the core leads into the termi-

nal holes from the left hand side. The insertion of the (+) and the (-) leads must be made simultaneously. Then fasten the leads in the terminals by turning the knobs clockwise. The layout of the speaker terminals is L  , L  , R  , R  from top to bottom.

For further details, refer to the "CONNECTION OF SPEAKER SYSTEMS" section of this manual.

12. OVERCURRENT PROTECTION FUSE

This device is provided to protect the amplifier from breakdown caused by unexpected abnormal current flow within the circuit. Especially, it functions to protect the amplifier when short circuiting takes place at the speaker terminals or cables of speakers. In the event sound playback is suddenly interrupted, immediately disconnect the power plug from an AC power point and check this fuse - - - turn the fuse holder cap counter-clockwise () to remove the fuse. If it was blown off, replace with a spare provided. Connection to the power point must be practised only after check and correction of the cause of overcurrent flow. The fuse used is a quick-blow 5A capacity fuse. The upside fuse is for the left channel and the downside fuse, the right channel.

13. AC MAINS POWER CORD

Connect the AC plug at the end of this cord to an appropriate single phase AC mains outlet in your listening room. For use with the model 5C50 control (pre) amplifier of the same LRS family, which is of a DC amplifier, the power plug of this cord can be connected to the AC OUTLET (SWITCHED) of the 5C50 and leave the power switch ON. By this the ON/OFF switching of this amplifier is coupled with that of the preamplifier.

14. EXTRA AC OUTLET

You can supply AC power to other audio equipment through this outlet. The terminal (UN-SWITCHED) is independent of the AC power switch of this amplifier. The maximum capacity is 500W.

Note that in some countries this outlet is not provided, because it is not allowed by law.

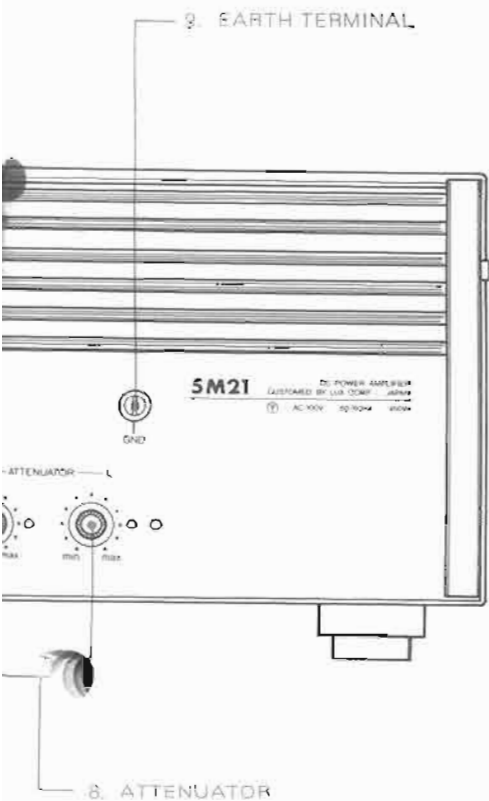

CONNECTION PROCEDURE

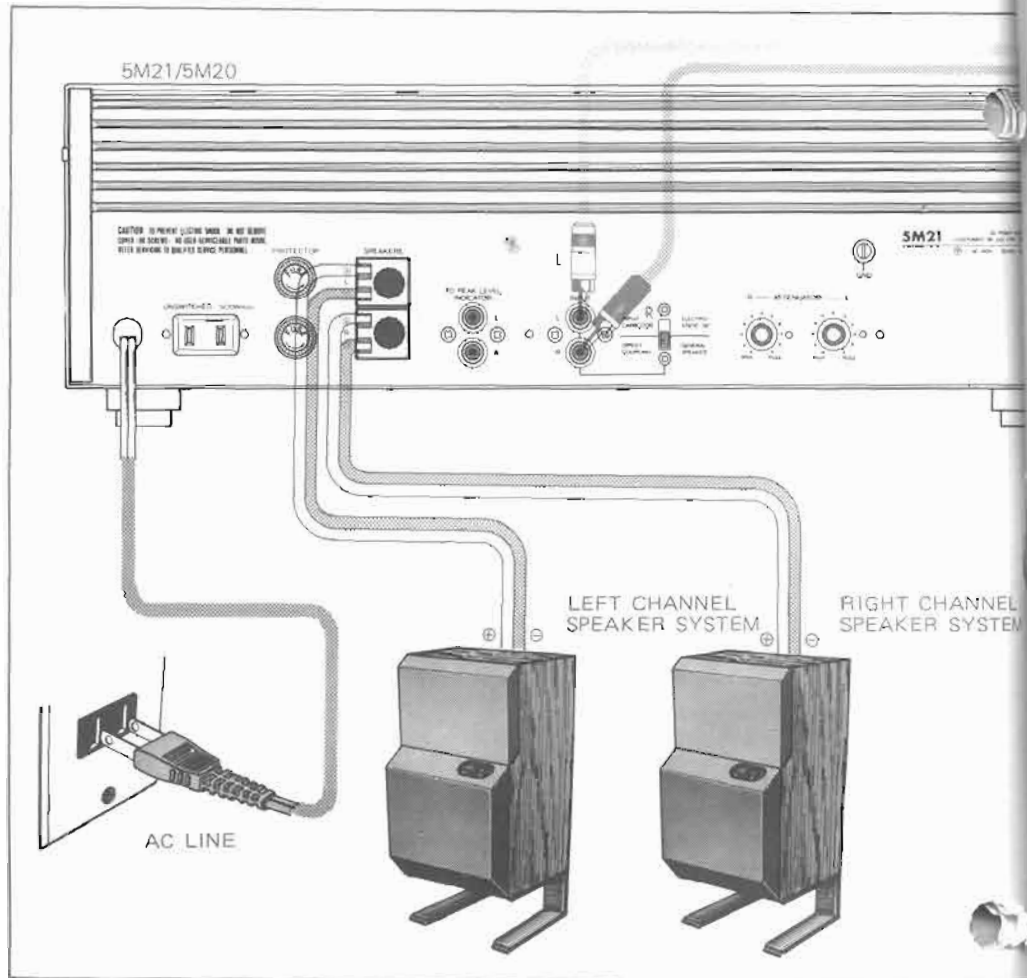

Connection to input terminals of the preamplifier

Outputs of recordplayer, FM stereo tuner, tape deck, etc. are connected to the corresponding input terminals of the preamplifier. Details of the connection procedure are described in the operation manual of the preamplifier.

Connection between the preamplifier output terminals and the input terminals

Connect the preamplifier output terminals to the input terminals (9) of the amplifier using the pin-plug cords. Make double check that outputs of the both channels are correctly connected to the corresponding input terminal.

Connection between the output terminals and the speaker systems

Stereophonic sound playback is made by a pair of speaker systems for the right and left channels. The lefthand side speaker system from the listening site must be connected to the left channel output terminals and the righthand side speaker

system to the right channel output terminals. If correct phase matching in the speaker connection is not established, phases of sound waves coming from the two speakers are deviated and normal stereo playback is not possible. The "correct phase matching" of the right and left channel speakers is realized by connection of the (+) output terminals with the (+) speaker terminals and the (-) output terminals with the (-) speaker terminals. When the connection is reversely made between the two speakers, phasing of the two speakers are reversed resulting in abnormal sound waves of the two speakers such as subdual of bass frequency range, unstable sound, etc. The terminal layout is L (+), L (-), (top) and R (+), R (-), (bottom). To connect the speaker cables to these terminals, observe the following procedure so that the core leads may not be short circuited: Strip off the PVC shield at the end of the cable for approximately 10mm (3") to expose the core leads. Twist the core leads. Caution is necessary not to break the leads during this practice. Then turn

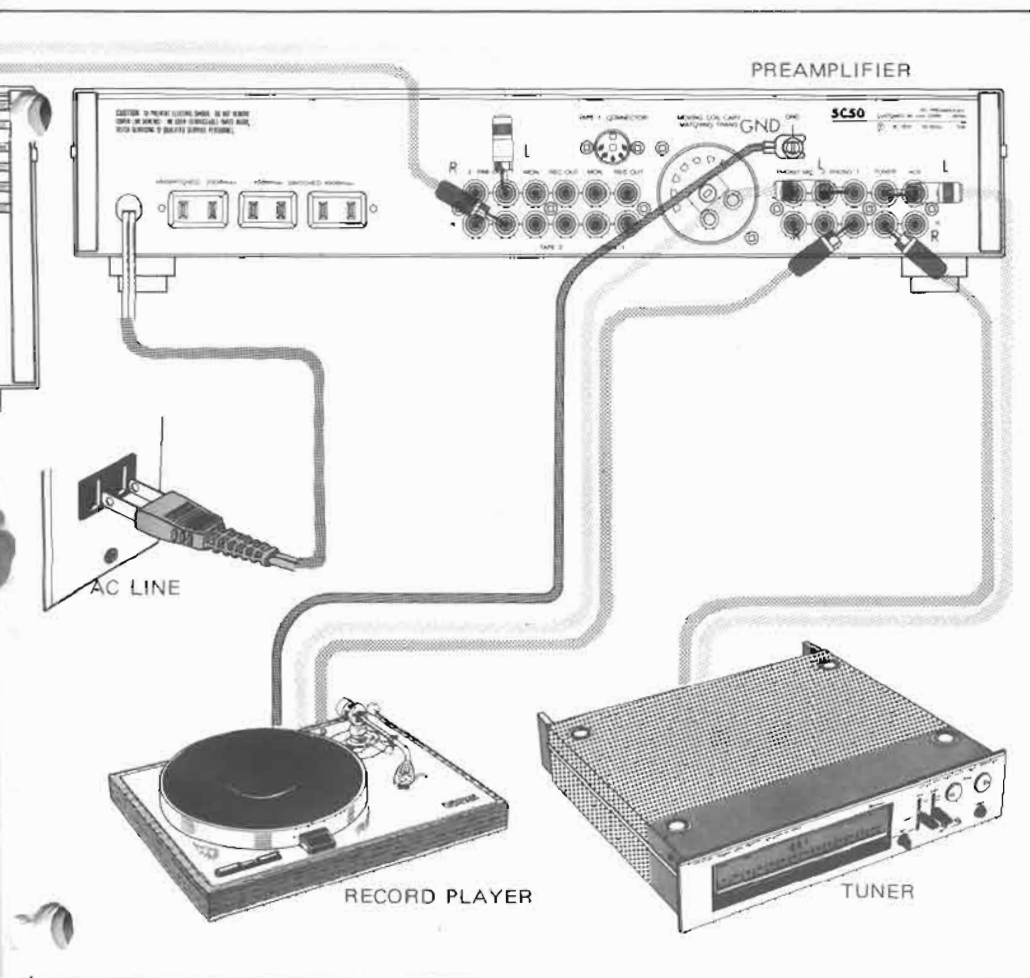

the knobs on the output terminals counter-clockwise (⊖) to loosen the terminal holes. Simultaneously insert the (+) and the (-) leads into the corresponding terminal holes from the lefthand side. Then turn the knobs clockwise (⊕) to clamp the leads. Bear in mind that the (+) and the (-) output terminals are designed to clamp the both speaker cables with uniform force at once. If any one of the two cables is solder-processed or thickness of the two cables varies, sufficient connection of the cables may not be possible.

Connection of power supply source

Connect the AC plug at the end of this amplifier's power cord (13) to an appropriate AC power point in your listening room. Press in the POWER SWITCH (5) and the power pilot light blinks for 5 ~ 20 seconds.

As soon as the amplifier comes to a normal operating condition, the light will cease to blink and kept illuminated. Simultaneously,

the VU meter illumination lamps light up. When the capacity of the annexed preamplifier's AC outlet is ample to handle the power consumption of this amplifier, the AC power plug can be connected to such outlet and leave the power switch ON so that coupled switching ON or OFF can be made by the power switch of the preamplifier.

Pin-Plug Cords

For connection of the record-player, tuner, and tape-recorder, use of shield wire is recommended for protection against external noise or inductance noise. Usually, this shield wire has a capacitance of approx. 200pF/m, and even so-called low capacitance shield wire has 35 - 100pF/m, i.e., the adoption of a connection cable gives the same effect as that of the insertion of a capacitor in parallel with input sources or output load equipment (which composes a kind of high-cut filter circuit).

All of LUXMAN products are so designed as to be low in output impedance and high in input impedance, which prevents such effect. But it is advisable to choose a shield wire of good quality and use it as short as possible for connection of this amplifier (at PHONO, AUX, Tape-monitor etc.) with the high impedance equipment.

ABOUT POWER OUTPUT PLACEMENT OF AMPLIFIER

About Power Output

This unit is provided with 2 toroidal power transformers with the least leakage and high heat efficiency in combination with 4 gigantic electrolytic capacitors (15,000 μ F), which makes it possible to ensure perfect independence of both right and left channels at the power supply source fed to the output stage of parallel push-pull configuration. Therefore one channel is kept immune from the influence given by the other and you can get without difficulty the rated output power of 100W/ch into 8 ohms loads.

With this unit such circuit that restricts the power output is not employed, because this gives an unfavorable influence on the playback sound from electrostatic loudspeakers etc.

The output power of 100W per channel (into 8 ohms) is not small, but rather classified into the category of high-powered amplifier. As far as this is used at the domestic listening room, it is not

always required to have such loudspeaker systems whose maximum input exceeds 100W.

Speaking about the overload handling capability, loudspeakers in general accept the instantaneous input power exceeding 5 times of the specified maximum input. Also when the input voltage into the power amp is reduced by half, the actual output power becomes one quarter. Therefore you can use loudspeakers of relatively low input capability. Select the loudspeakers that reproduce your favorable sound rather than care about the input overload characteristics.

The 5M21 is equipped with 2 large VU meters to show the average output level. If you want to monitor the instantaneous peak output, it is recommended to purchase the 5E24 peak indicator unit of our Laboratory Reference Series. The following table shows the correlation between the meter's indication level and the power output. (only for the 5M21)

RMS vs. output level (dB) (only for the 5M21)

meter indication	meter sensitivity 0dB			meter sensitivity -10dB		
	output voltage (V)	Bohm load (W)	4ohm load (W)	output voltage (V)	Bohm load (W)	4ohm load (W)
+ 3dB	40	200	400	12.7	20	40
+ 2dB	35.7	160	320	11.3	16	32
+ 1dB	31.6	125	250	10	12.5	25
0 dB	28.3	100	200	9	10	20
- 1dB	25.2	80	160	8	8	16
- 3dB	20	50	100	6.3	5	10
- 6dB	14.2	25	50	4.5	2.5	5
- 8dB	11.3	16	32	3.6	1.6	3.2
- 10dB	9	10	20	2.8	1	2
- 20dB	2.8	1	2	0.9	0.1	0.2
- 30dB	0.9	0.1	0.2	0.3	0.01	0.02

Placement of Amplifier

The 5M21(5M20) is a high power output amplifier of DC-amp configuration, adopting class "AB" operation in the output stage. Therefore, it is necessary to choose such location that effective heat-radiation is possible.

In the case of transistorized power amplifier, most of electric power is consumed in power transistors and the heat-sink contributes to radiate heat. The heat-sink of the 5M21(5M20) is placed to

the back side, where good ventilation is indispensable, otherwise temperature inside of the unit increases to give decisive damage to the components. Therefore the thermal protector is provided to sense the temperature of heat sink when it exceeds 90°C, and terminate the operation of amplifier.

Ideally the back-side should be thoroughly free, and at least be careful so that heat-radiation is done smoothly.

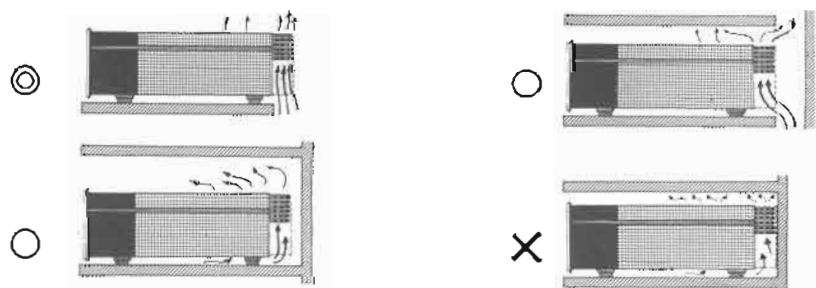

Operation Procedure

Upon accomplishment of all the preparations described in the "CONNECTION PROCEDURE" in this manual, playback of program sources can be made through this amplifier. However the following procedure is further necessary to drive the amplifier under its best operating condition.

1. Turn the ATTENUATOR knobs (8) to the complete counter-clockwise end to set them at the MIN. position. Also completely turn the volume control knobs of the mating preamplifier counter-clockwise to cut off the output.
2. Turn on the power switches of the preamplifier and this amplifier. Almost all current models of amplifier are so designed that during warming up, the output circuit is isolated which is normally referred to as the muting time. The muting time of this amplifier is 5 ~ 20 seconds and during this period, the DC OFFSET SENSOR/PILOT LAMP (4) gives blinking indication. After the muting time, the lamp continues to illuminate to indicate the amplifier is standing by for playback operation. It is necessary

that the input selector of the pre-amplifier is selected at the correct position for a desired program source.

3. Turn the ATTENUATOR (8) knobs (for the both channels) of this amplifier completely clockwise to set them at the MAX. position. Then turn the preamplifier volume control clockwise until appropriate playback volume is obtained. When the output level of preamplifier falls to be too high, regulation can then be made by the ATTENUATOR (8) by turning the knobs counter-clockwise.

4. When the playback level is low and the amplifier is driven for output power far below its rating, meter needle reading of the VU METER may be difficult. In such case press in the METER SENSITIVITY SELECTOR (2) to set it at the -10dB position. By this the meter sensitivity is boosted by 10dB. Relationship between dB (decibel) calibration on the METER and the POWER OUTPUT is described in the "RMS output level" described in the "ON POWER OUTPUT" section of this manual.

OPERATION PROCEDURE LEGS RACK-MOUNTING

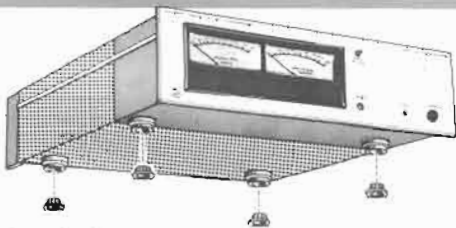

Attached leg caps

The illustration is for the 5M21 power amplifier, but all the models in Laboratory Reference Series adopt the same construction for smooth placement.

About Legs

All the components in our Laboratory Reference Series are provided with the legs at the bottom and the metallic receptacles on the top, and metallic support is placed between the leg and its receptacle. Thus you need not worry about breakage caused by an accumulated weight even when they are stacked one by one, as the total weight is given to the legs of the very unit placed at the bottom of such stack. Perfect fit between the legs and receptacles prevents each component unit from falling or sliding.

However if the unit is placed on the furniture or other kind of wooden cases, with these legs as they are, it is possible to cause a slip or scratch. To prevent this,



Rack Mount Adapters

4 leg caps of synthetic resin are provided as accessories. When some of the components in our Laboratory Reference Series are stacked, the leg caps should be attached to the legs of the last unit placed at the bottom of such stack. To fix them refer to the drawing.

About Rack-Mounting

In order to mount the 5M21 or the 5M20 to the rack of EIA standard, adapters are available on request. Note that the size of the adapter varies from one product to another in our Laboratory Reference Series.

PROTECTIVE CIRCUITS

The amplifier integrates a sensor and three protective circuits to provide fail-safe safety measures for protection of speakers and the amplifier itself. Function of the DC OFFSET SENSOR is detection of DC ingredient leakage fed to the input terminals of this amplifier from an annexed audio component such as a preamplifier. When such DC ingredients are supplied, normal functioning levels at various stages of the amplifier may be deviated and speakers may be ill-treated resulting in break-down. The DC DRIFT PROTECTION CIRCUIT functions to protect speakers when sensing a DC exceeding a permissible limit at the output terminals. The HEAT SINK ABNORMAL HIGH TEMPERATURE SENSING CIRCUIT is provided for protection of the power transistors that may malfunction or break-down when the heat sink temperature elevates exceeding the limit owing to insufficient heat dissipation.

The OVERCURRENT PROTECTIVE CIRCUIT is to protect the power transistors from break-down when overcurrent flow is caused owing to short circuiting of the speaker cords, etc.

DC OFFSET SENSOR

This amplifier is of DC amplification circuitry integrating perfect measures to inhibit DC drifting within the amplifier circuits.

However, DC leakage from a mating preamplifier that may be fed to the input terminals of this amplifier may likely occur. Such leakage causes abnormal function of amplifier circuits resulting in deterioration of performance characteristics. It is also possible that amplified DC ingredients are fed to speakers to give harmful effect or break them. The DC OFFSET SENSOR is provided in order to constantly monitor the presence of such injurious DC ingredients at the output terminals so that the amplifier can always be driven for its normal functions.

The DC OFFSET SENSOR LAMP/POWER PILOT LAMP (4) illuminates in white when no DC ingredients are fed to the input terminals of this amplifier. When a DC voltage of more than $\pm 450\text{mV}$ appears at the output terminals, the color of lamp turns to red from white to give visual warning that harmful DC ingredients are fed to the input terminals. If such warning is made, immediately select the INPUT CAPACITOR IN/OUT SELECTOR (7) at the INPUT

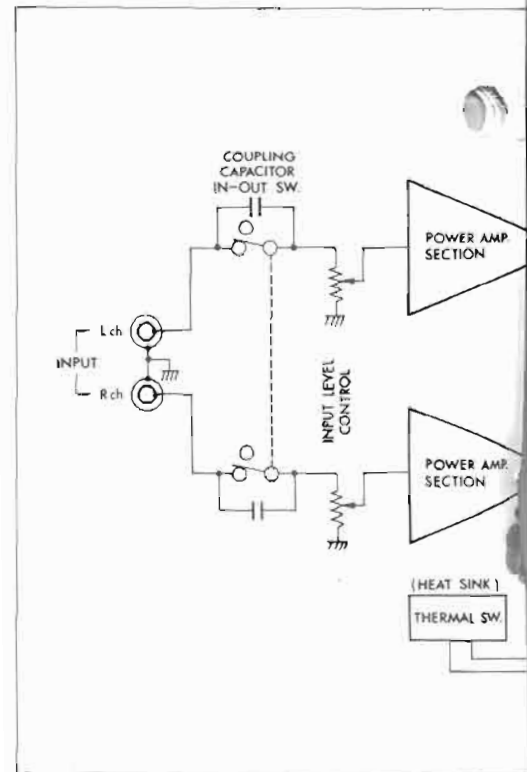

CAPACITOR position. By doing so, such DC ingredients are shut off and the color of lamp returns to white within 2 ~ 3 seconds after the selection indicating the normal operating condition of the amplifier.

DC DRIFT PROTECTION CIRCUIT

This safety device is actuated when DC ingredients supplied to the input terminals of this amplifier come out of the output terminals of this amplifier, or when owing to malfunction of the amplifier elements DC ingredients are fed to the output terminals of this amplifier.

Function of this protective device is to isolate speakers from the amplifier circuitry. The functioning level of this circuit is $\pm 3\text{V}$ or more DC voltage sensed at the output terminals.

Actuation of this device can be visually confirmed by blinking of the DC OFFSET SENSOR LAMP/POWER PILOT LAMP (4) in white color. Such indication is a warning that harmful DC ingredients are leaked from the output terminals of an annexed audio component. In such case the INPUT CAPACITOR IN/OUT SELECTOR (7) must be selected at the INPUT CAPACITOR position. By this the DC ingredients are completely shut off and the pilot lamp will discontinue blinking and return to stay in white illumina-

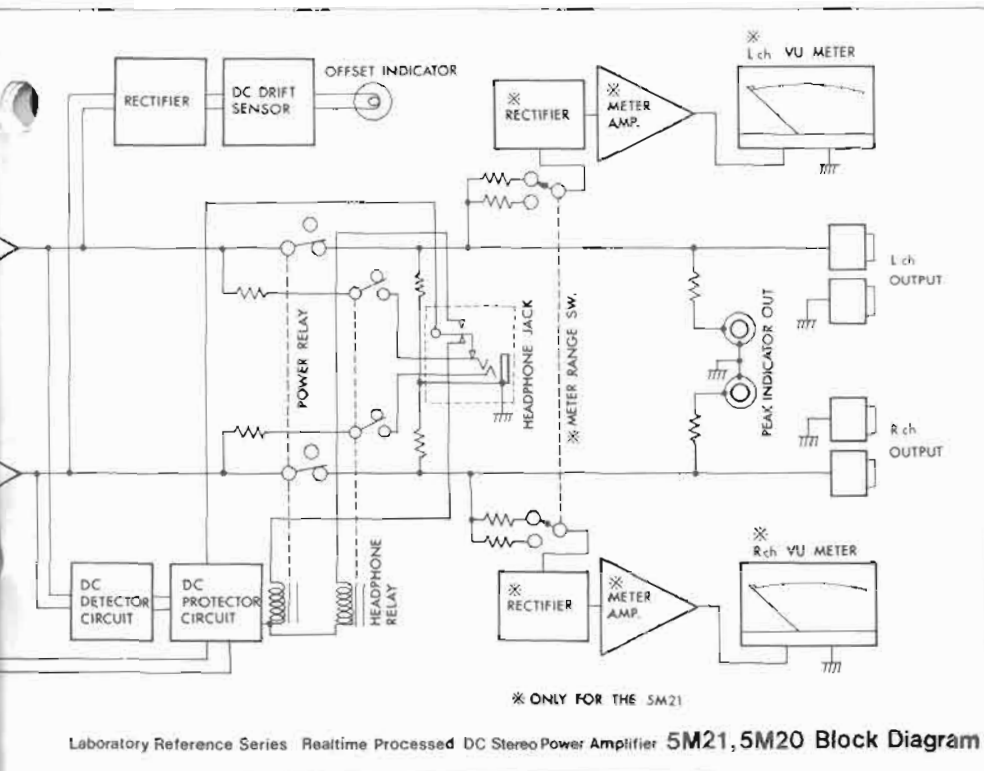

nation. Thus the normal operation of the amplifier is possible.

If the pilot lamp continues to give blinking warning even after the selection of the INPUT CAPACITOR switch, the cause of such warning is presumably due to abnormal function of the circuit of this amplifier itself. In such case immediately switch off the power switch (5) and contact your nearest LUX authorized service station.

HEAT SINK ABNORMAL TEMPERATURE SENSING CIRCUIT

Power transistors generate heat when they are driven for high power output. A specially designed flat type heat sink is used for effective heat dissipation from the power transistors to maintain the power transistor in the normal operation temperature range. The heat sink of this amplifier is designed to make effective heat dissipation under normal operating conditions. However when the amplifier is placed in an air tight chamber, or located where it is subject to direct sunlight and driven for nearly full power output, sufficient heat dissipation cannot be made and temperature of the power transistors will elevate to hazardous level. The protective circuit is preset to function for protection of the amplifier when temperature of the heat sink becomes 90°C or higher.

When this circuit is actuated,

the DC OFFSET SENSOR/PILOT LAMP (4) begins to blink in white. The circuit will automatically reset the amplifier as time elapses to lower the heat sink temperature.

However it is important that the cause of overheating must be corrected or removed before re-operation of the amplifier.

OVERCURRENT PROTECTIVE CIRCUIT

In the event speaker terminals of this amplifier, or speaker leads are short circuited, an overcurrent flows back to the power transistors resulting in their break-down.

The overcurrent protection fuse contained in the fuse holder (12) is a quick-acting type 5 amp fuse. This fuse will blow when short circuiting occurs to protect the power transistors.

When sound is suddenly interrupted, disconnect the AC power plug on the power cord (13) from a quick-acting type 5A fuse. This fuse will blow when short circuiting occurs to protect the power transistors.

If it was blown, replace it with a spare provided. However it is important that the cause of overcurrent must be thoroughly checked and remedied before supplying power.

BLOCK DIAGRAM

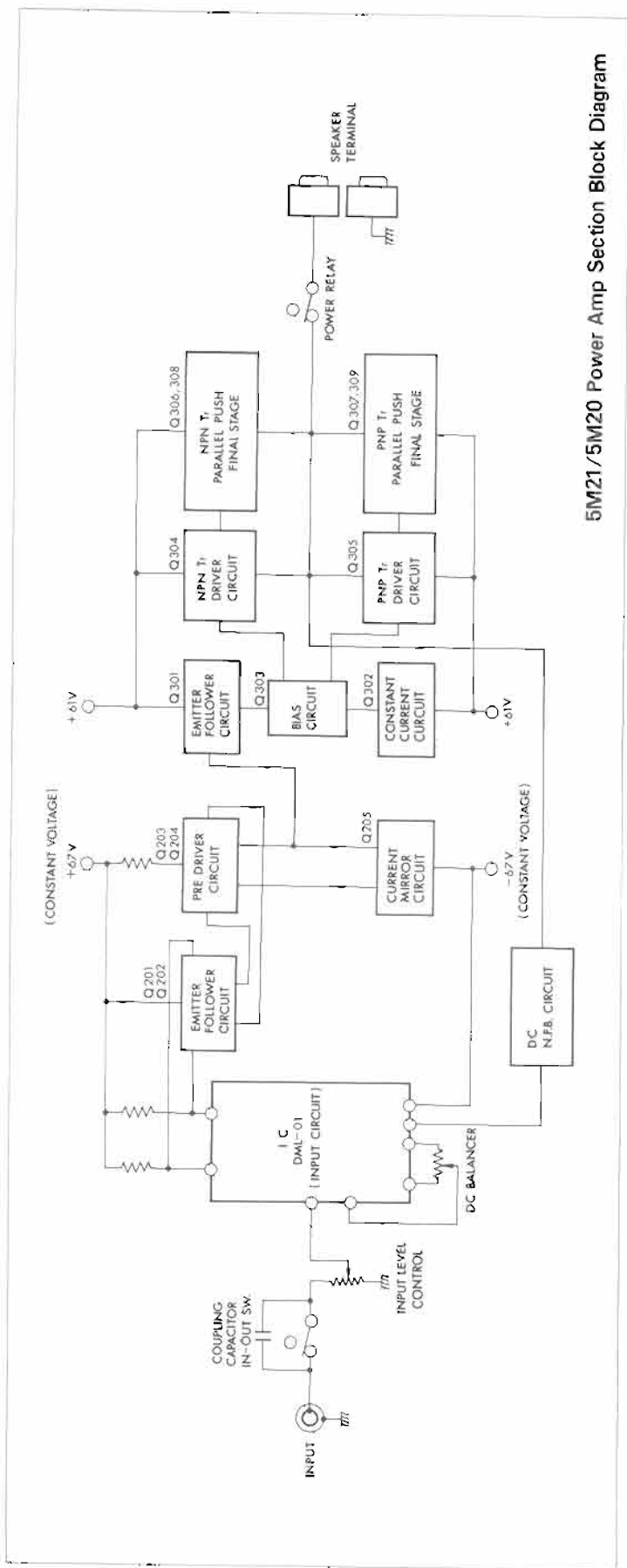

5M21/5M20 Power Amp Section Block Diagram

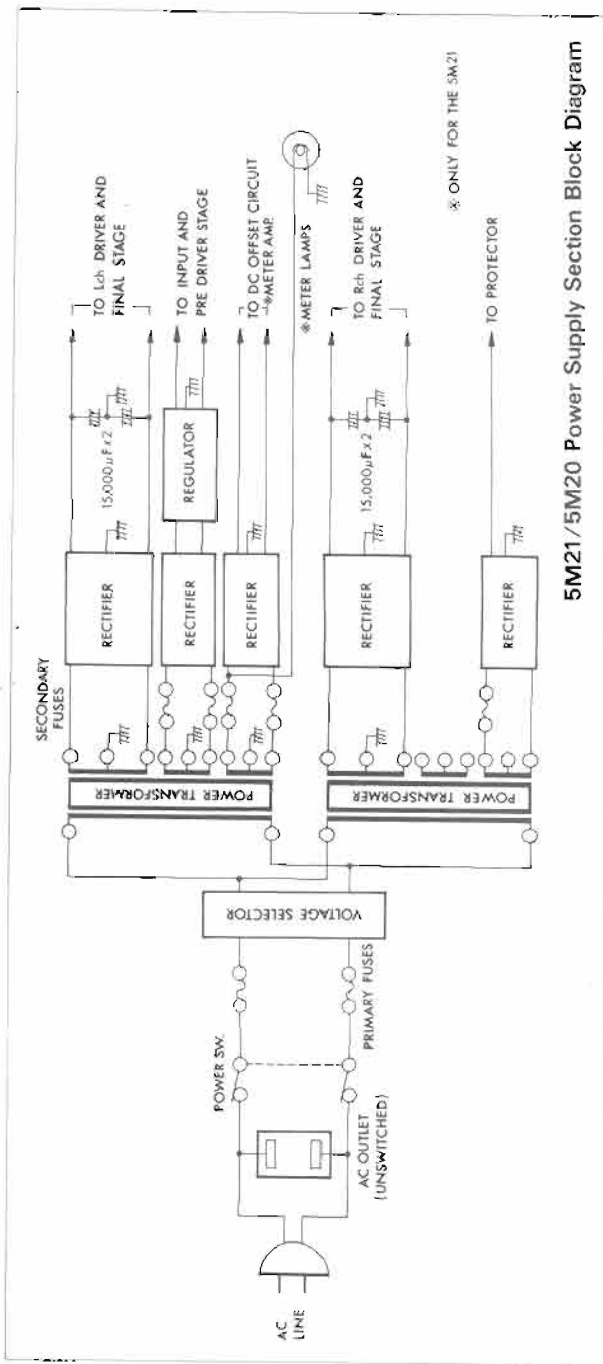

5M21/5M20 Power Supply Section Block Diagram

STANDARD CURVES

5M21/5M20 T.H.D. VS. POWER (8Ω, BOTH CH. DRIVEN, DIST. METER ; ST-1700B)

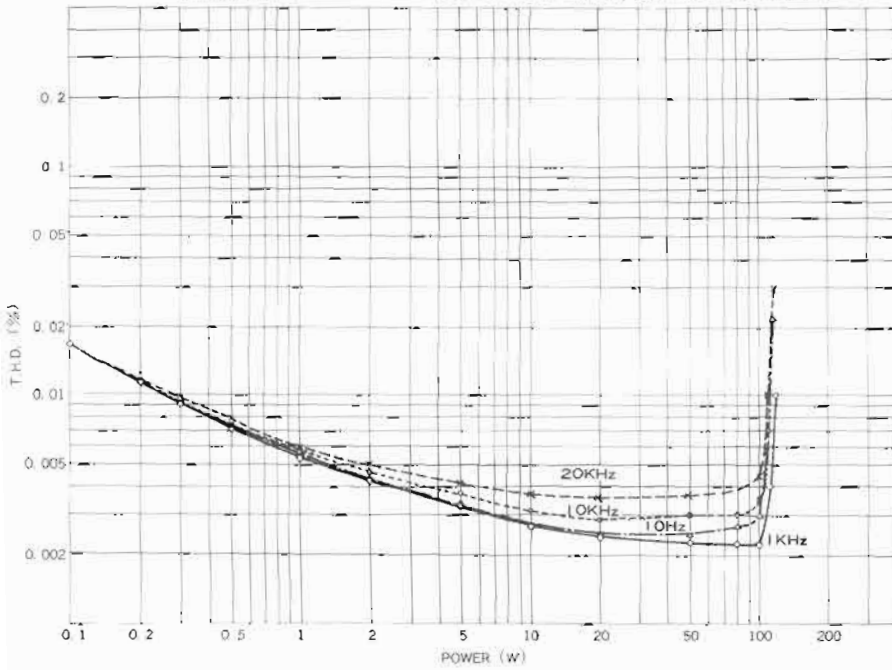

5M21/5M20 T.H.D. VS. FREQUENCY (8Ω, BOTH CH. DRIVEN)

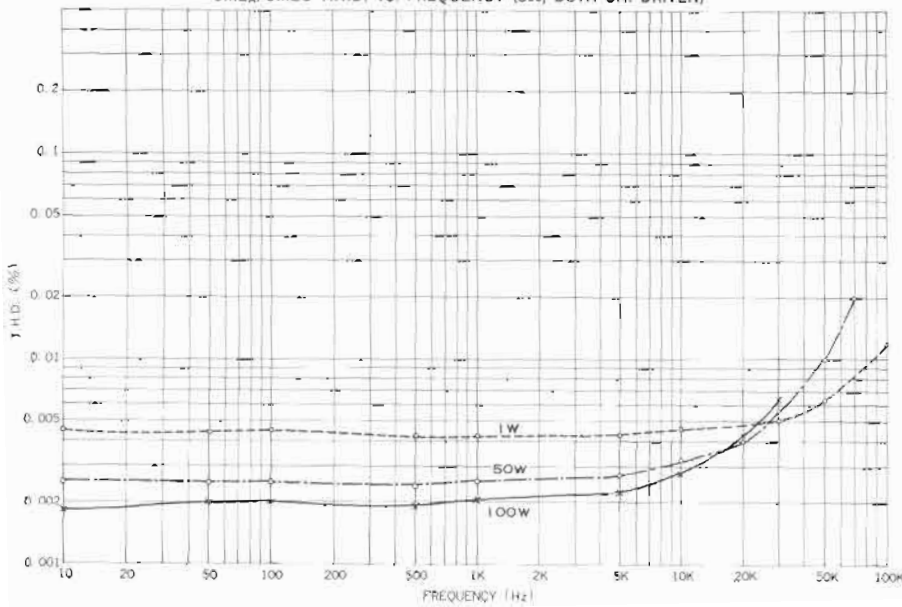

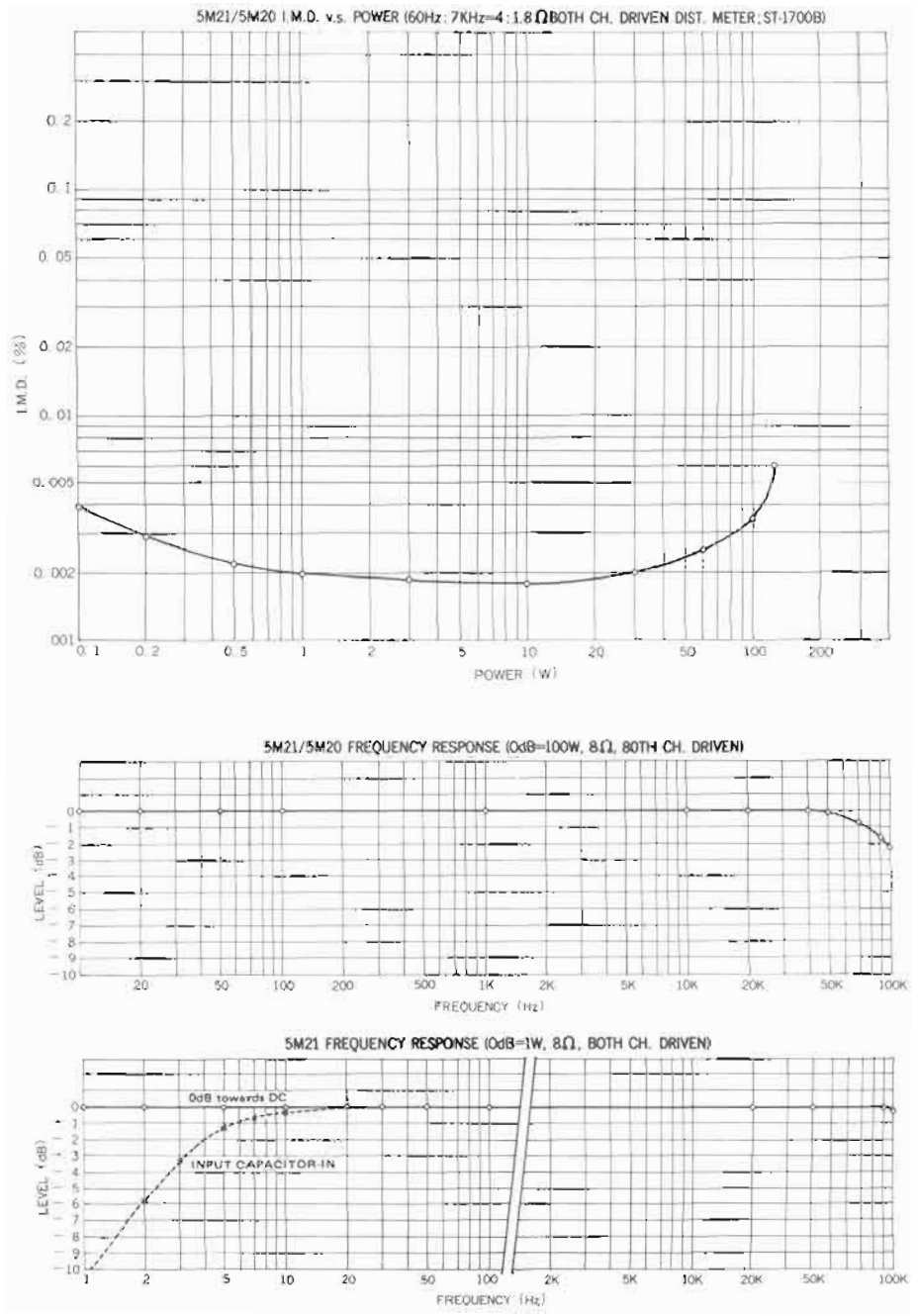

5M21/5M20 CROSSTALK (POWER: 100W, VOLUME: MAX)

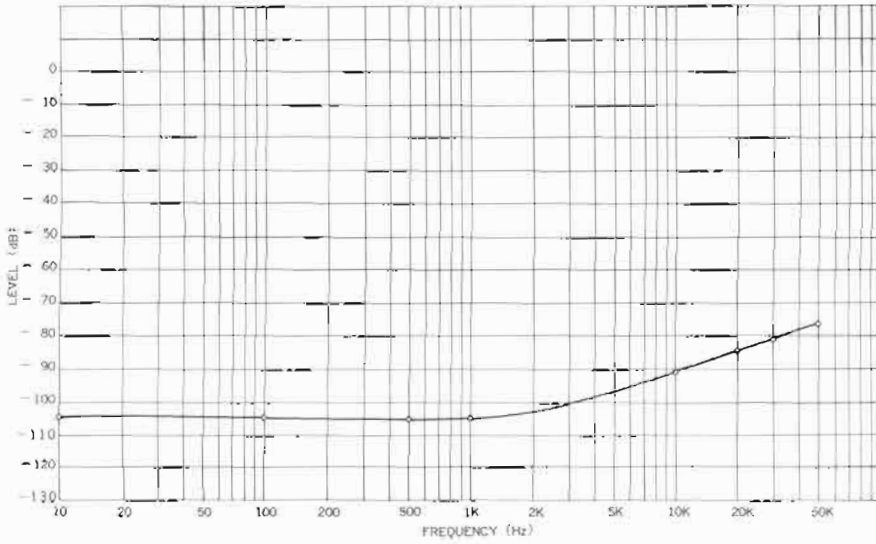

5M21/5M20 PHASE CHARACTERISTIC

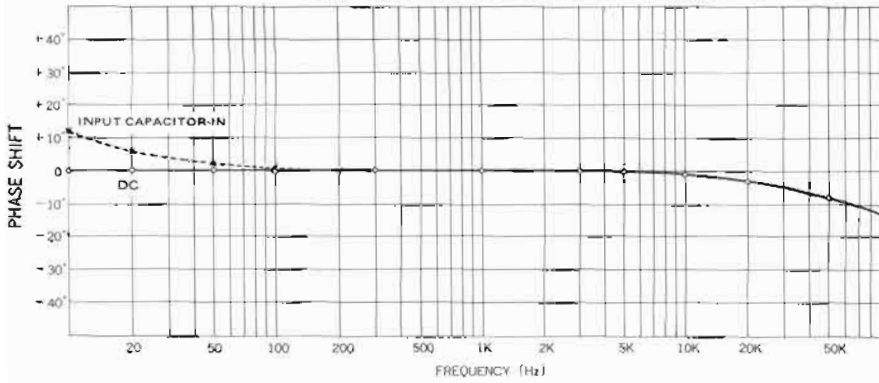

SPECIFICATIONS

[5M21]

Power Output:	100W minimum continuous per channel into 8-ohm loads, both channels driven at any frequency from 10Hz to 20,000Hz with no more than 0.008% total harmonic distortion
Rated I.M.:	no more than 0.008% (8-ohm, 60 : 7KHz = 4 : 1)
Frequency Response:	DC~100,000Hz (-1dB)
Input Sensitivity:	890mV
Input Impedance:	50k ohms
Signal to Noise Ratio:	120dB (IHF A-curve, input short-circuit)
Residual Noise:	no more than 0.1mV (input short-circuit)
Crosstalk:	no more than -100dB (100Hz) no more than -70dB (20 - 20kHz)
Damping Factor:	80 (8-ohm, 1kHz)
Other Features:	VU meter for left & right channels, Meter sensitivity selector switch (0dB, -10dB) Input capacitor IN/OUT switch Audio attenuator for both channels Connection terminal for Peak indicator Extra AC outlet (unswitched)
Protection Circuits:	DC offset senser, DC-drift sensing circuit, Abnormal temperature sensing circuit, Excessive current protection circuit
Semiconductors:	DML-IC (2), transistors (49), Diodes (43)
Power Consumption:	450W (8-ohm, at maximum output)
Dimensions:	442(W) x 400(D) x 146(H) mm (17-13/32 x 15-3/4 x 5-3/4")
Weight:	Net 19kgs (41.8 lbs.) Gross 21kgs (46.2 lbs.)

[5M20]

Power Output:	100W minimum continuous per channel into 8-ohm loads, both channels driven at any frequency from 10Hz to 20,000Hz with no more than 0.008% total harmonic distortion
Rated I.M.:	no more than 0.008% (8-ohm, 60 : 7KHz = 4 : 1)
Frequency Response:	DC~100,000Hz (-1dB)
Input Sensitivity:	890mV
Input Impedance:	50k ohms
Signal to Noise Ratio:	120dB (IHF A-curve, input short-circuit)
Residual Noise:	no more than 0.1mV (input short-circuit)
Crosstalk:	no more than -100dB (100Hz) no more than -70dB (20 - 20kHz)
Damping Factor:	80 (8-ohm, 1kHz)
Other Features:	Input capacitor IN/OUT switch Audio attenuator for both channels Connection terminal for Peak indicator Extra AC outlet (unswitched)
Protection Circuits:	DC offset senser, DC-drift sensing circuit, Abnormal temperature sensing circuit, Excessive current protection circuit
Semiconductors:	DML-IC (2), transistors (45), Diodes (31)
Power Consumption:	450W (8-ohm, at maximum output)
Dimensions:	442(W) x 400(D) x 146(H) mm (17-13/32 x 15-3/4 x 5-3/4")
Weight:	Net 18.8kgs (41.4 lbs.) Gross 20.8kgs (45.8 lbs.)

*Specification and appearance design are subject to possible change without notice.

LUX CORPORATION, JAPAN

1-1, 1-CHOME, SHINSENRI-NISHIMACHI, TOYONAKASHI
OSAKA, JAPAN PHONE: 06-834-2222 TELEX: J636

LUX AUDIO OF AMERICA, LTD.

200 AERIAL WAY, SYOSSET, NEW YORK 11791 U.S.A.